



Sovitron Interior Pvt.Ltd.



Model Name

Sigma Soft Pendant / DLASSSSDPD-50

Description

Architectural Light

Technical description

Dimension	L=900mm H=60mm/90mm
Frame	Aluminium
Color Tempertaure	5700K
Power	50W
Total Luminous Flux	4500 lm
Efficacy	90 lm/W
IP rating	50
Color Rendering	≥80
Mounting	Pendant
Optics	White Opal Diffuser
Dimming	NON-Dimmable
Operating Voltage	220-240 VAC
Standard Lifetime	L70 minimum at 50,000 burning hours

Image

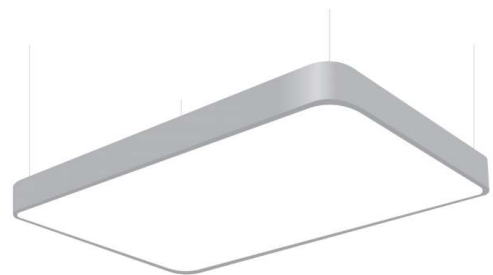

Dimension diagram

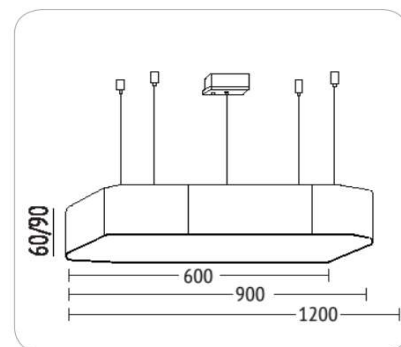

Custom dimension, coating and installation
available upon request

Remarks:-

Address: Plot #7 Saroorpur-Nangla Industrial Area,Ballabgarh-Sohna Road,Faridabad-121005

Email: info@sovitron.com